

Objective

Sardegna in-ground light with beacon offers a resourceful, indirect light option for all landscape lighting needs. The light body adopts the 6063 aluminium alloy moulding, surfaced with anodizing treatment. Faceplate uses high corrosion stainless steel and the lampshade adopts high strength toughened glass. The light is bright, pure and uniform and the effect in the outdoor application is very good looking.

Obiettivo

La luce da terra con faro di Sardegna offre un'opzione di luce indiretta e piena di risorse per tutte le esigenze di illuminazione paesaggistica. Il corpo leggero adotta lo stampaggio in lega di alluminio 6063, con trattamento di anodizzazione. Il frontalino utilizza acciaio inossidabile ed il paralume adotta vetro temperato ad alta resistenza. La luce è brillante, pura e uniforme e l'effetto nell'applicazione esterna è di bella presenza.

Description

Housing - Made of high corrosion die cast aluminum with high corrosion stainless steel 309 or 316 trim cover with choice of RAL colors. Sealed with silicon gasket rubber.

Diffuser - Tempered Glass diffuser specially for LED









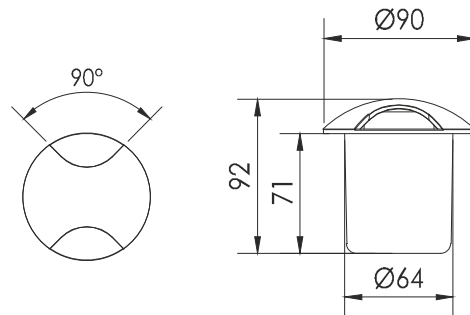





LED - reducing energy consumption with L80/B10/F10 50,000 hrs lifetime.

Standards - manufactured in accordance with EN 60598-1 and 60598-2-1

Accessories- Recessed PVC box.

CODE	WATTAGE	LUMEN	SIZE mm	
1101004	4W	480lm	Ø90 X 92 H	Ø64



		
PHASE DIMMING		
	Glowing Wire Test - 850°	
IP 67	IK 09	UGR <21
		
	SMD	CRI >90
	SELV	
		
A++	DC 24V	85-265V 50/60Hz

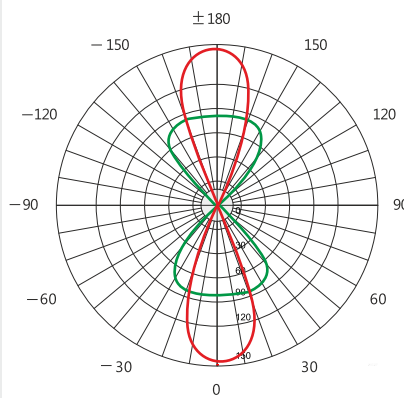

1000 KG LOAD



2700K
3000K
4000K
5000K
6000K



LED Drivers - PHILIPS    TRIDONIC  BRIDGELUX  SHARP  PHILIPS  CITIZEN

In a continuing effort to offer the best product possible, we reserve the right to change, without notice, specifications or materials that in our opinion will not alter the function of the product. Specification sheets found at www.romaluce.it are the most recent versions and supercede all other printed or electronic versions.