

Objective

A wide choice of wattage options plus the chance to decide between reflector or opal diffuser to reply ad every question. The high quality of the materials and the finish are ratifying this item as high quality, high resistance and long lasting one. Thanks to its design and the advanced technologies contained inside it, this item guarantees high lumen output with no glare effect and homogeneous enlightenment.

Obiettivo

Una vasta scelta di opzioni nel wattaggio più l'opportunità di decidere tra riflettore o diffusore opaco per rispondere ad ogni domanda. L'alta qualità dei materiali e della finitura sanciscono questo prodotto come di alta qualità, alta resistenza e lunga vita. Grazie al suo design ed alle avanzate tecnologie in esso racchiuse, l'articolo garantisce un'alta resa in lumen senza effetto abbagliante ed un'illuminazione omogenea.

Description

Housing - Die cast aluminium powder coated with choice of RAL colors

Diffuser - Optical PMMA lens.











Reflector - Polished specular anodized aluminium.

LED - reducing energy consumption with L80/B10/F10 50,000 hrs lifetime.

Standards - manufactured in accordance with tested as per PTPS IEC 62722

CODE	WATTAGE	LUMEN	SIZE [D x H]	
5091505	5W	625lm	Ø103 X 58H	Ø90
5091509	9W	1125lm	Ø103 X 58H	Ø90
5091515	15W	1875lm	Ø144 X 66H	Ø125
5091520	20W	2500lm	Ø183 X 80H	Ø160
5091530	30W	3750lm	Ø266 X 93H	Ø200
5091540	40W	5000lm	Ø266 X 93H	Ø200



		
PHASE DIMMING	DALI	1-10 DIMMING
	Glowing Wire Test - 850°	
IP 65		SDCM 2.0/3.0
	EAC	COMPLIANCE
PASEL ACCREDITATION	COB	CRI >90
	SELV	series wiring
		
A++	85-265V 50/60Hz	

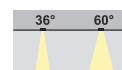
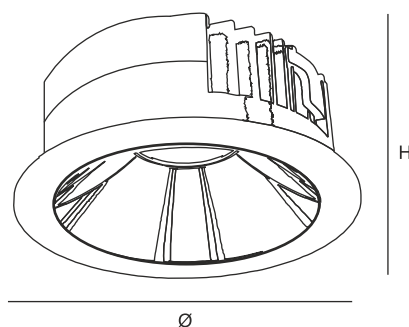
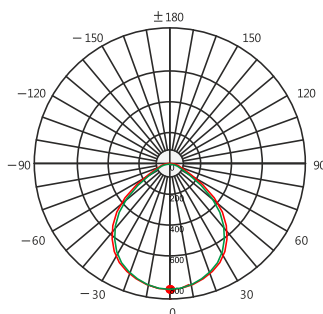

- 2700K
- 3000K
- 4000K
- 5000K
- 6000K
- 6500K



LED Drivers - PHILIPS    TRIDONIC | LED Chips - BRIDGELUX    PHILIPS  Micro HumanTech

In a continuing effort to offer the best product possible, we reserve the right to change, without notice, specifications or materials that in our opinion will not alter the function of the product. Specification sheets found at www.romaluce.it are the most recent versions and supercede all other printed or electronic versions.