

Objective

Elegant by name, this down light with deep cone and excellent design provides high quality enlightenment with its LED efficient technology. The signature here is also the quality of its finish and the extreme attention to the choice of finest quality and resistance of the materials, from the die-cast aluminium heat sink, through the aluminium reflector, till the tempered glass diffuser. Available in different sizes to satisfy every architectural needs, friend of the environment thanks to its energy saving system, beautiful to look, this luminaire is suitable to be utilized everywhere.

Obiettivo

Elegante per nome, questa luminaria da soffitto con una sottile cornice ed un design eccellente provvede ad un alta qualità dell'illuminazione con la sua tecnologia LED altamente efficiente. La firma qui è anche la qualità della finitura e l'estrema attenzione alla scelta della migliore qualità e resistenza dei materiali, dal dissipatore in alluminio pressofuso, passando per il riflettore in alluminio, arrivando al diffusore in vetro temperato. Disponibile in varie taglie per soddisfare ogni necessità architettonica, amica dell'ambiente grazie al suo sistema di risparmio energetico, bellissima da guardare, questa luminaria è adatta per essere utilizzata ovunque.

Description

Housing - Die cast aluminium solvent free powder coated with choice of RAL colors

Diffuser - Tempered clear or frosted glass.











Reflector - Tiles pattern reflector made by highly specular anodized aluminium

LED - reducing energy consumption with L80/B10/F10 50,000 hrs lifetime.

Standards - manufactured in accordance with tested as per PTPS IEC 62722

CODE	WATTAGE	LUMEN	SIZE mm	
5094513	13W	1560lm	Ø100 X 85 H	Ø85
5094520	20W	2400lm	Ø138 X 95 H	Ø115
5094525	25W	3000lm	Ø165 X 100 H	Ø145
5094535	35W	4200lm	Ø190 X 110 H	Ø175



		
PHASE DIMMING	DALI	1-10 DIMMING
	Glowing Wire Test - 850°	
IP 54		SDCM 2.0/3.0
	EAC	COMPLIANCE
PASEL ACCREDITATION	COB	CRI >90
	SELV	series wiring
		
A++	85~265V 50/60Hz	

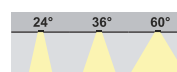
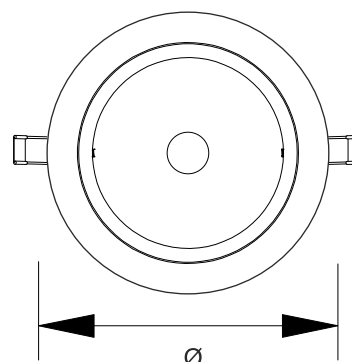
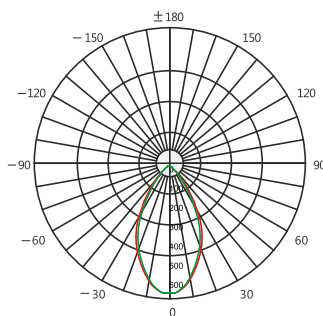

TRIO
2700K
3000K
4000K
5000K
6000K
6500K



LED Drivers - PHILIPS    TRIDONIC | LED Chips - BRIDGELUX    PHILIPS 

In a continuing effort to offer the best product possible, we reserve the right to change, without notice, specifications or materials that in our opinion will not alter the function of the product. Specification sheets found at www.romaluce.it are the most recent versions and supercede all other printed or electronic versions.