



## \*\*\*INSTALLATION MANUAL\*\*\*

### Safety tips before starting

- \*Let always an expert/authorized technician make the installation.
- \*Before you start please shut off the power to prevent electric shock.
- \*The products with energetic class II do not require the Earth / Ground connection so please do not connect the neutral if is not required. Instead, if the item is class energetic I, please do connect the neutral to Earth.
- \*Consider always to leave some space for the heat sink of the led device, it need it to cool down after use
- \*Do not connect any Led device without its recommended driver
- \*Your individual product may vary from the design shown in the pictures
- \*Do not disassemble your product
- \*If any modification is made in the item or any wrong installation cause any damage to it, the warranty will be invalidated.

#### STANDARD RECESSED INSTALLTION

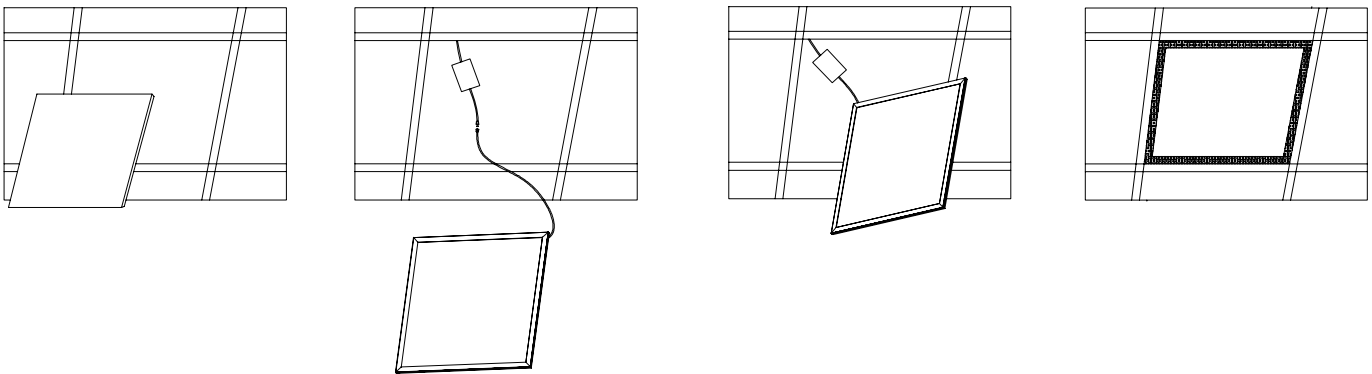

1.. Remove ceiling plaster

2.. Connect the poer supply

3.. Fix the panel light  
into the right place

4.. Stabilize the pan

#### SUSPENDED INSTALLTION

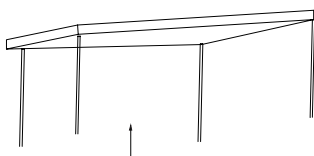

1.. .Fix the anchor into  
target place on the ceiling  
Fix the installation mount  
on the ceiling with plastic anchor

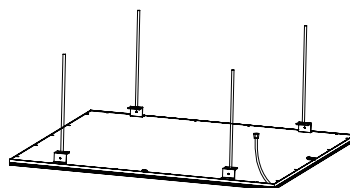

2.. Hang the panel to ceiling  
with suspended installation kits

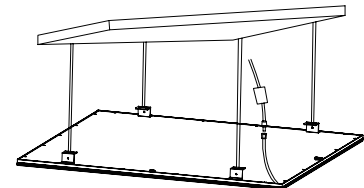

3.. Adjust the length of the wire  
Connect the power supply

- \*Please note that this item is coming as standard without accessories, so suitable for standard recessed installation.
- If you plan to proceed another installation, please make sure you order the related accessories.

**Thanks for your purchase !**



## \*\*\*INSTALLATION MANUAL\*\*\*

### SUSPENDED INSTALLTION

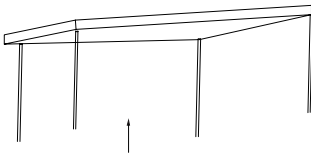

1.. Fix the anchor into target place on the ceiling  
Fix the installation mount on the ceiling with plastic anchor

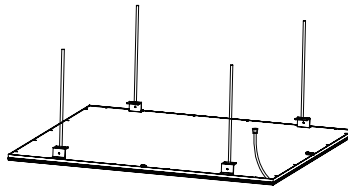

2.. Hang the panel to ceiling with suspended installation kits

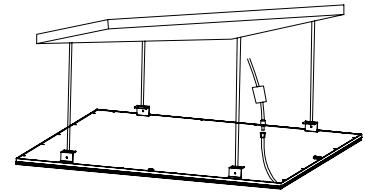

3.. Adjust the length of the wire  
Connect the power supply

\*Please note that this item is coming as standard without accessories, so suitable for standard recessed installation.  
If you plan to proceed another installation, please make sure you order the related accessories.

**Thanks for your purchase !**