



INSTALLATION MANUAL

Safety tips before starting

- *Let always an expert/authorized technician make the installation.
- *Before you start please shut off the power to prevent electric shock.
- *The products with energetic class II do not require the Earth / Ground connection so please do not connect the neutral if is not required. Instead, if the item is class energetic I, please do connect the neutral to Earth.
- *Consider always to leave some space for the heat sink of the led device, it need it to cool down after use
- *Do not connect any Led device without its recommended driver
- *Your individual product may vary from the design shown in the pictures
- *Do not disassemble your product
- *If any modification is made in the item or any wrong installation cause any damage to it, the warranty will be invalidated.

Dos and Don'ts

- 1.Install in the IP 65 environment or beneath the IP66.
- 2.Prohibit punching any position of lamps
3. Please turn off the power and contact the dealer for problems in connection or other abnormal cases.
- 4.Installed by the qualified electrician holding a certificate.
- 5.Prohibit operating the lamps beyond the voltage scope as nation stipulated
- 6.Don't make the external power cable exposed during wiring.

Romana with Spike

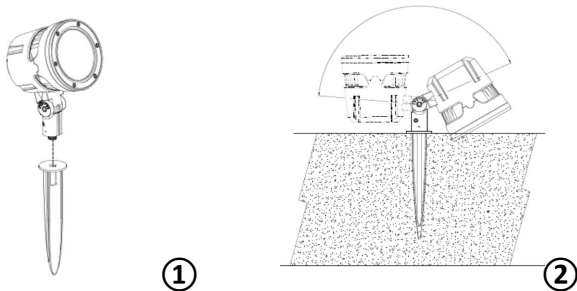

Step①, assemble the spike into the fixture, then insert the spike into ground.
(if the fixture received is with the spike, please insert into the ground directly)

Step②, adjust the bracket as your project needed.

Notes: The same bracket with any anti-glare accessories don't influence the installation method, the specific installation method is subject to what exactly fixtures you receive.
Notes: The fixture must get reliable connection with the mounting surface, any screws in the lamps should not be arbitrarily loosed. There is no special requirement on the installation direction.

Romana with Base

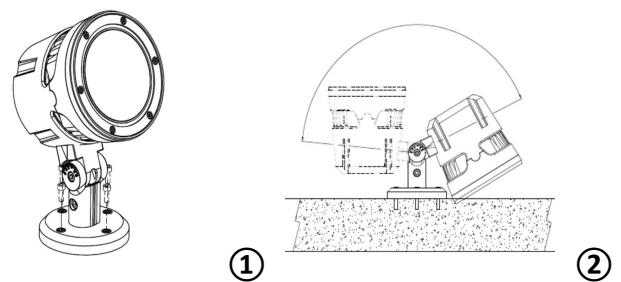

Step①, fix the bracket on the mounting surface.

Step②, adjust the bracket as your project needed.

Notes: The same bracket with any anti-glare accessories don't influence the installation method, the specific installation method is subject to what exactly fixtures you receive.
Notes: The fixture must get reliable connection with the mounting surface, any screws in the lamps should not be arbitrarily loosed. There is no special requirement on the installation direction.

Thanks for your purchase !



INSTALLATION MANUAL

Romana with Bracket

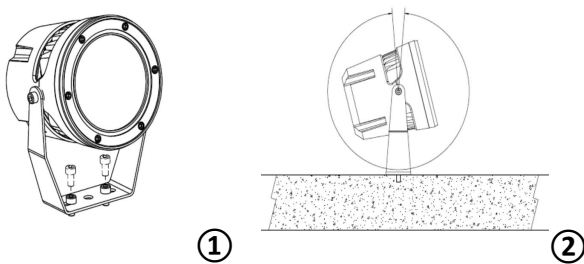

Step①, fix the bracket on the mounting surface by screws.

Step②, adjust the bracket as your project needed.

Notes: The same bracket with any anti-glare accessories don't influence the installation method, the specific installation method is subject to what exactly fixtures you receive.
Notes: The fixture must get reliable connection with the mounting surface, any screws in the lamps should not be arbitrarily loosened. There is no special requirement on the installation direction.

Romana with Pole Kit

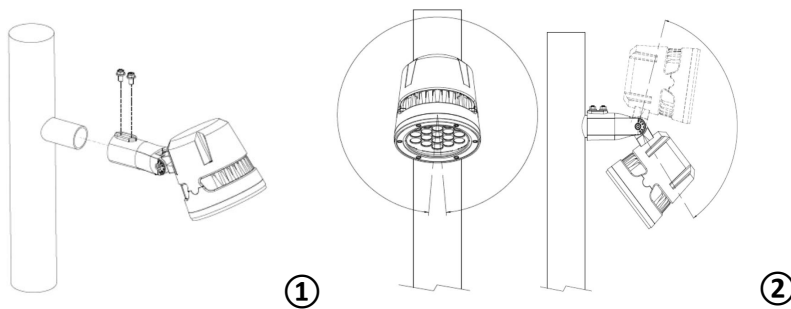

Step①, install the arm into the pole.

Step②, adjust the bracket as your project needed.

Notes: The same bracket with any anti-glare accessories don't influence the installation method, the specific installation method is subject to what exactly fixtures you receive.
Notes: The fixture must get reliable connection with the mounting surface, any screws in the lamps should not be arbitrarily loosened. There is no special requirement on the installation direction.

Thanks for your purchase !



INSTALLATION MANUAL

Romana Wiring

--- Single Color

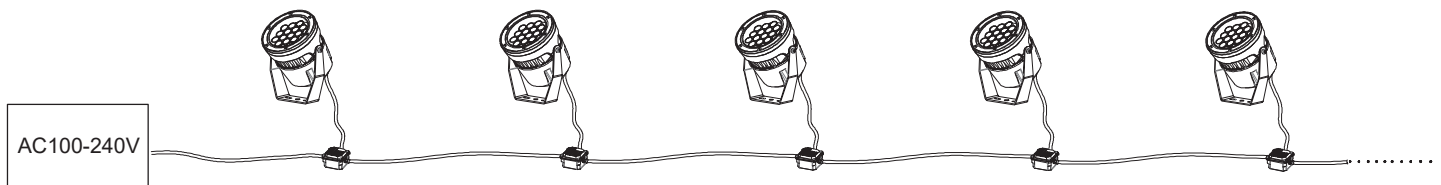

--- RGB option 1

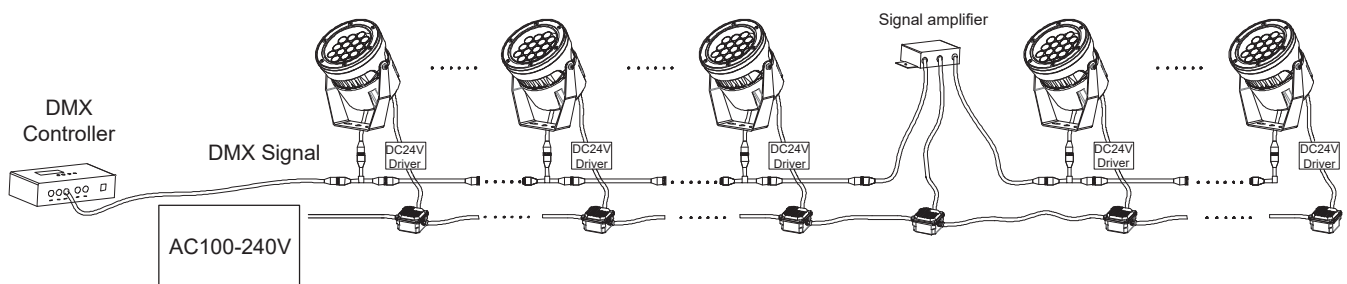

--- RGB option 2

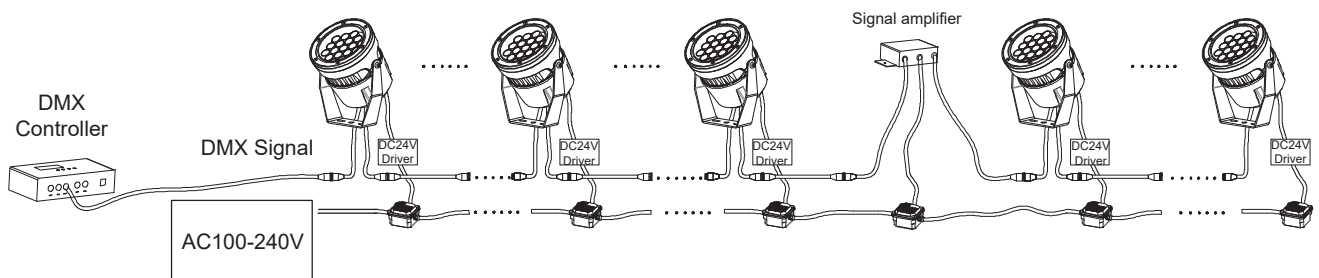

Thanks for your purchase !