

Objective

Owing to our years of experience, we are able to offer the Littely line of in-ground light. Superior quality raw material and high edge machines are used in the manufacturing process. The products here offered are in strict compliance with the global quality standards. This products are acknowledge for their features like shock resistance, rust proof and durability, all in the small size. The 316 high corrosion stainless steel housing given freedom of installation in variant ground circumstances hardscape or softscape.

Obiettivo

Grazie alla nostra esperienza pluriennale, siamo in grado di offrire la linea di luci incassate a pavimento Littely. Nel processo di produzione vengono utilizzate materie prime di qualità superiore e macchine di alto livello. I prodotti qui offerti sono in stretta conformità con gli standard di qualità globali. Questi prodotti sono riconosciuti per le loro caratteristiche come resistenza agli urti, resistenza alla ruggine e durata, il tutto nella piccola dimensione. L'alloggiamento in acciaio inossidabile 316 ha dato la libertà di installazione in condizioni di terreno variabile hardscape o softscape.

Description

Housing - High corrosion stainless steel 316 trim sealed with silicone gasket in stainless steel, with option of powder coating RAL finish.

Diffuser - STG (Step Tempered Glass) diffuser specially for LED with optical function lens or frosted tempered glass.

















LED - reducing energy consumption with L80/B10/F10 50,000 hrs lifetime.

Standards - manufactured in accordance with EN 60598-1 and 60598-2-1

Accessories - Prismatic glass, honeycomb, asymmetric glass, recessed PVC box.

CODE	WATTAGE	LUMEN	SIZE mm	
1108602	1.5W	175lm	Ø35 X 45H	Ø50 X 83H
1108603	3W	315lm	Ø50 X 51H	Ø67 X 83H



			
PHASE DIMMING	DALI	1-10 DIMMING	
	65°C	Glowing Wire Test - 850°	
IP 66	IK 09	UGR <21	SDCM 2.0/3.0
		COMPLIANCE	
	COB	CRI >90	
	SELV		series wiring
			
A++			DC 24V

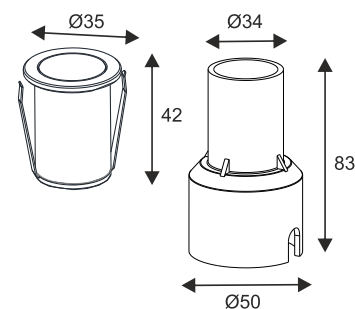
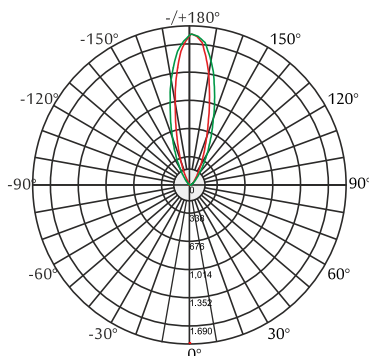

 Honeycomb

200KG LOAD



RGB
2700K
3000K
4000K
6000K

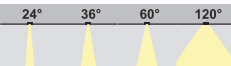



LED Drivers - PHILIPS    TRIDONIC | LED Chips - BRIDGELUX    PHILIPS 

In a continuing effort to offer the best product possible, we reserve the right to change, without notice, specifications or materials that in our opinion will not alter the function of the product. Specification sheets found at www.romaluce.it are the most recent versions and supercede all other printed or electronic versions.