

**Objective**

Typical recessed underwater light with all Roma Luce team experience. The resultant light is bright, pleasant, homogeneous and comfortable. Suitable for pool area especially, but even where more resistance to hard weather and humidity conditions is required. The LED is high efficient and promises considerable energy saving applicable for underwater level of 2000mm. Fixture has two versions of ingress protection for wet soil area which comes high humidity area required anti corrosion body.

**Obiettivo**

Tipica luce subacquea ad incasso tipica con tutta l'esperienza del team Roma Luce. La luce risultante è luminosa, piacevole, omogenea e confortevole. Adatto soprattutto per l'area piscina, ma anche dove è richiesta una maggiore resistenza alle intemperie e alle condizioni di umidità. Il LED è altamente efficiente e promette un notevole risparmio energetico applicabile per un livello subacqueo di 2000 mm. Il dispositivo ha due versioni di protezione dall'ingresso per l'area del suolo umido che viene fornita con un corpo anti corrosione richiesto per l'area ad alta umidità.

**Description**

**Housing** - Made of 316L high corrosion resistance stainless steel sealed with silicon & rubber gasket.

**Diffuser** - Tempered Glass diffuser specially for LED

**Reflector** - Anodized aluminum reflector.









**LED** - reducing energy consumption with L80/B10/F10 50,000 hrs lifetime.

**Standards** - manufactured in accordance with EN 60598-1 and 60598-2-1.

**Accessories**- Recessed PVC box.

CODE	WATTAGE	LUMEN	SIZE mm	
1100904	4W	420lm	Ø80 X 100 H	Ø75
1100906	6W	630lm	Ø80 X 100 H	Ø75
1100908	8W	840lm	Ø80 X 100 H	Ø75



		UGR <21	SDCM 2.0/3.0
PHASE DIMMING	DALI	1-10 DIMMING	
65°C	Glowing Wire Test - 850°		
-20°C	IP 67	IK 10	Operation Under Soil
	EAC	COMPLIANCE LM-79 TM-21 LM-80	
PASEL ACCREDITATION	SMD	CRI >90	
	SELV		series wiring
CE			U
<b>A++</b>	DC 12V	DC 24V	

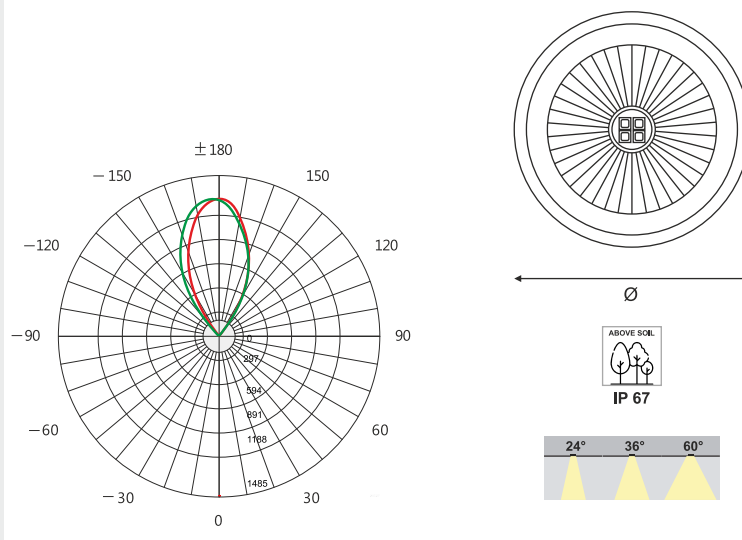

LED Drivers - PHILIPS    TRIDONIC | LED Chips - BRIDGELUX    PHILIPS 

In a continuing effort to offer the best product possible, we reserve the right to change, without notice, specifications or materials that in our opinion will not alter the function of the product. Specification sheets found at [www.romaluce.it](http://www.romaluce.it) are the most recent versions and supercede all other printed or electronic versions.